

# **HOB0<sup>®</sup>**

## Data Loggers

**HOB0 MX800 Series**

**User Guide**

# Table of Contents

Introduction .....	4
MX800 Loggers, Sensors, and Accessories .....	4
Download the HOBObconnect App and Access Logger Functions .....	6
HOBOb MX801 Submersible Logger Quick Start Guide .....	9
Overview .....	9
Connect a Sensor to the Logger .....	9
Calibrate the Sensor .....	11
Configure the Logger .....	11
Mount and Deploy the Logger .....	12
Download the Data .....	13
Process the Data .....	13
HOBOb MX802 Direct Read Logger Quick Start Guide .....	16
Overview .....	16
Connect the Cable and Sensor to the Logger .....	16
Calibrate the Sensor .....	18
Mount and Deploy the Logger .....	18
Configure and Start the HOBOb MX802 Logger Using HOBObconnect ..	19
Download the Data .....	19
HOBOb MX800 Series User Guide .....	20
Logger Components and Operation .....	20
Set up the DO Sensor .....	21
Configure Logger Operation .....	22
Set up Alarms .....	26
Select Which Channels to Log .....	28
Set the Specific Conductivity Temperature Compensation Value .....	28

Mount and Deploy the MX801 Logger .....	29
Mount and Deploy the MX802 Logger .....	31
Take Reference Water Level Measurements (MX801 and MX802) ....	34
Download Data From the Logger .....	36
Post-Processing Data to Extract Other Parameters .....	36
Maintain the Logger and Sensors .....	38
Use a Conductivity Sensor Anti-Fouling Guard .....	41
Use a DO Sensor Anti-Fouling Guard .....	42
Logger Events .....	42
Pressure Sensor Drift .....	43
Conductivity Sensor Calibration .....	44
DO Sensor Calibration .....	48
Measurement Calculations .....	52
Specifications .....	53
HOBO MX801/802 Specifications .....	53
CTD Sensor Specifications .....	56
CT Sensor Specifications .....	61
DO Sensor Specifications .....	63

# Introduction

The HOBO MX800 Series logger provides a single integrated platform for monitoring a range of critical water parameters. The currently available sensors track multiple parameters and are available in the following combinations:

- conductivity, temperature, and depth (CTD)
- conductivity and temperature (CT)
- dissolved oxygen and temperature (DO)

The loggers include built-in Bluetooth for quickly and wirelessly downloading data. The HOBO MX800 series Bluetooth loggers come in an easy-to-deploy fully submersible model (MX801), as well as a direct read model (MX802) for conveniently downloading data that doesn't require having to remove the sensor from the water. Use this single platform for monitoring multiple water parameters, featuring interchangeable sensors, easy calibration and setup, and user-replaceable batteries.

## MX800 Loggers, Sensors, and Accessories

Model Name	Part Number
<b>Loggers</b>	
HOBO MX801 Submersible Logger	MX801
HOBO MX802 Direct Read Logger	MX802
<b>Sensors</b>	
Dissolved Oxygen Sensor	W-DO
Conductivity Sensor	W-CT
CTD Sensor, 9 Meter (30') range	W-CTD-01
CTD Sensor, 30 Meter (100') range	W-CTD-02
CTD Sensor, 76 Meter (250') range	W-CTD-03
CTD Sensor, 4 Meter (13') range	W-CTD-04

**Cables (Note: You can also order a custom cable length.)**

1.0m W-Series Sensor Cable	CABLE-W-1.0
2.0m W-Series Sensor Cable	CABLE-W-2.0
5.0m W-Series Sensor Cable	CABLE-W-5.0
10m W-Series Sensor Cable	CABLE-W-010
15m W-Series Sensor Cable	CABLE-W-015
30m W-Series Sensor Cable	CABLE-W-030
60m W-Series Sensor Cable	CABLE-W-060

**Included Items:**

Tapered coupler	Included with HOBO MX801 or MX802 data logger
3/32" Allen wrench	Included with HOBO MX801 or MX802 data logger
Straight coupler	Included with cables

**Required Items**

HOBOconnect Software	N/A
----------------------	-----

**Accessories**

Plug for Unused Sensor Inputs	W-PLUG
Protective Housing for MX801 Loggers	HOUSING-1

Additional sensors and accessories are available at [www.onsetcomp.com](http://www.onsetcomp.com).

## Download the HOBObconnect App and Access Logger Functions

Install the HOBObconnect app to connect to the logger.

1. Download HOBObconnect to a phone or tablet from the App Store® or Google Play™.
2. Download the app to a Windows computer from:  
[www.onsetcomp.com/products/software/hobobconnect](http://www.onsetcomp.com/products/software/hobobconnect)
3. Open the app and enable Bluetooth in your computer's device settings, if prompted.
4. Wake up the logger by holding the magnet fob on the WAKE magnet icon on the logger until the LEDs flash.

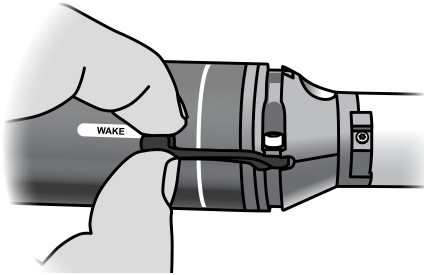













5. In the app, tap Devices and then tap the logger tile to connect to the logger.



If the logger does not appear in the list or if it is having trouble connecting, follow these tips:

- Make sure the logger is awake by holding the magnet fob on the WAKE magnet icon on the logger.  
Tapping this icon again brings the logger to the top of the list if you are working with multiple loggers.
- Make sure the logger is within range of your mobile device or computer. The range for successful wireless communication is approximately 30.5 m (100 ft) in air with full line-of-sight.
- Change the orientation of your device to ensure the antenna is pointed toward the logger. Obstacles between the antenna in the device and the logger may result in intermittent connections.
- If your device can connect to the logger intermittently or loses its connection, move closer to the logger, within sight if possible. Bluetooth signals do not go through water, so if the logger is underwater, it must be pulled out of the water to connect to it.
- If the logger appears in the app, but you cannot connect to it, close the app and then power down your device to force the previous Bluetooth connection to close.

Once the logger is connected, you can:

Tap this Icon:	To do this:
	Customize Configuration & Start allows you to specify logger settings and save them to the logger and start logging. See <a href="#">Configure Logger Operation</a> .

	Tap to view live data.
	Download Data. See <a href="#">Download Data From the Logger</a> .
	Clear Alarms. Clears the current alarm.
	Add to Favorites allows you to mark the logger as one of your favorites. You can then filter the list of devices to show only loggers marked as favorites. Tap this icon to unmark the logger as a favorite.
	Lock the logger. Set a password for the logger so that it is not mistakenly stopped or reconfigured. Tap the icon, enter a password, and then tap Set. Once you enter a password on phone or tablet, that mobile device will be the only one to remember it. This means you can connect to the logger without entering a password on that mobile device, but you will be required to enter a password on all other mobile devices. For example, if you set the password for the logger with your tablet and then try to connect to the device later with your phone, you will be required to enter the password on the phone but not with your tablet. Similarly, if others attempt to connect to the logger with different devices, then they would also be required to enter the password.
	Manage Password. Reset your existing password or set a new password for the logger.
	Conductivity Calibration. See <a href="#">Conductivity Sensor Calibration</a> .
	Reset to Factory Conductivity Calibration.
	Enter the reference water level and water density before starting the logger (MX802 logger with CTD sensor only).
	Calibrate the DO percent saturation. See <a href="#">DO Sensor Calibration</a> .
	Calibrate the DO concentration. See <a href="#">DO Sensor Calibration</a> .

	Illuminate the logger LEDs for five seconds.
	Start logging if the logger was configured to start with a button push. See <a href="#">Configure Logger Operation</a> .
	Stop logging data (this overrides any Stop Logging settings described in <a href="#">Configure Logger Operation</a> ).



# HOBO MX801 Submersible Logger Quick Start Guide

## Overview

The HOBO MX801 Submersible Logger is designed to be used with compatible HOBO W-Series sensors to log water parameters such as temperature, conductivity, depth and more.

This logger must be deployed with the sensors attached, as it is not waterproof if sensors are not attached.

If you are using this logger with two sensors, you will need to use the 2-sensor adapter. See the manual that comes with that adapter for attaching the two sensors.

The following is an overview of the steps for configuring and deploying the logger:

1. [Connect a Sensor](#)
2. [Calibrate the Sensor](#)
3. [Configure the Logger](#)
4. [Mount and Deploy the Logger](#)
5. [Download the Data](#)
6. [Process the Data](#)



**Note:** If you are using either a W-CTD or W-CT sensor and it has not been in water, we recommend attaching the sensor to the MX801 logger and soaking the sensor in tap water for 24 hours before performing a conductivity calibration.

## Connect a Sensor to the Logger

1. Take the rubber cap off the end of the logger.
2. Connect the sensor to the logger by aligning the alignment pin on the sensor with the hole on the logger connector. Do not force the connection because you do not want to bend any of the pins.



**Note:** When assembling the logger or attaching the cable, make sure the o-rings and cable connector surfaces are clear of any debris and that the o-rings are lightly lubricated. Any contamination on these surfaces can cause leaks that lead to logger failure. The loggers and cables come from the factory with the proper amount of lubricant.

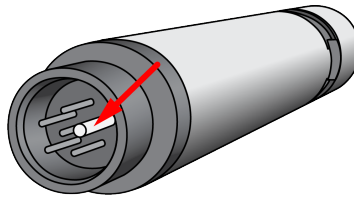

3. Attach the tapered coupler over the connection between the sensor and the logger. To do so, ensure the magnetic fob is attached to one half of the tapered coupler. Snap one side of the coupler over the connection between the sensor and the logger with the tapered end toward the sensor. Slide the other half of the tapered coupler over the connection and press the two parts together; listen for a snap. The fob should be able to slide into its home when the pieces are together. See the following illustrations.

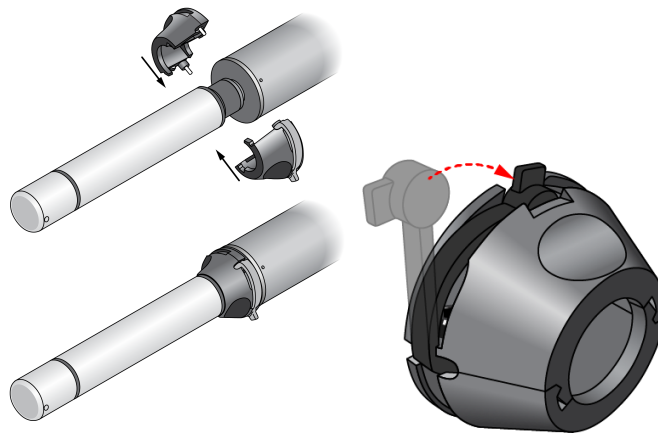

4. Tighten the tapered coupler screws with the allen wrench that is included with the logger. You may need to move the magnetic fob out of the way.
5. Insert the magnetic fob into its holding spot on the coupler.



**Note:** It is normal for there to be a small gap between the coupler and the logger. Note also that it is normal for the coupler to rotate around the connection. This allows you to rotate the magnetic fob to where you can easily reach the magnet icons for activating logger functions.

### Install the Sensor Cap (DO Sensor only)

if you are using a DO sensor, you must install the DO sensor cap. The sensor is not waterproof without the cap. See [Set up the DO Sensor](#).

## Download and Open HOBObconnect

You need to use HOBObconnect with the HOBOb MX Series loggers. To download HOBObconnect go to:

[www.onsetcomp.com/products/software/hobobconnect](http://www.onsetcomp.com/products/software/hobobconnect)

## Calibrate the Sensor

If you are using CTD, CT, or DO sensors, calibrate them in your office or lab before configuring the loggers for deployment. The HOBObconnect app guides you through the basic calibration steps. To achieve the best calibration accuracy, refer to [Conductivity Sensor Calibration](#) or [DO Sensor Calibration](#).

## Configure the Logger

### Logging Water Level or DO Percent Saturation Requires Barometric Pressure

If you are using the MX801 logger with a CTD sensor to measure water level, you should deploy a barometric pressure logger nearby (within 10 miles) to log barometric pressure changes. Or, if you are logging DO and you want to see the data in percent saturation, you should deploy a DO logger at the site. You can use a HOBOb MX802 logger or a HOBOb MX2001 logger to log barometric pressure. These require a cable and sensor to be attached to make them weatherproof, or use a termination plug (W-PLUG, shown below) on the MX802. HOBObconnect uses the barometric pressure data in combination with the CTD pressure data to calculate water level or with DO concentration data to calculate DO percent saturation.

Attach the W-PLUG to the MX802 logger using the tapered coupler the same way you attached the sensor to the MX801.

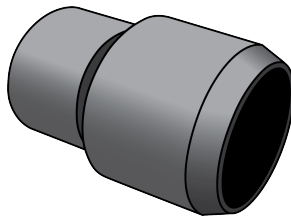

Use HOBObconnect to configure the logger you will be using to record barometric pressure:

1. If you are using an MX802 logger, you may need to wake it using the magnetic fob. To do so, hold the magnetic fob on the WAKE magnet icon as shown in the following illustration.

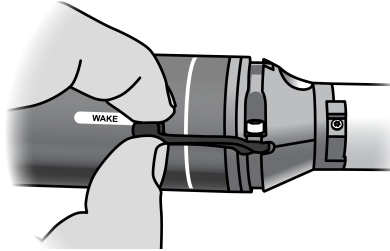

2. Configure the Logging Interval and Start Logging setting to be same as what you will be using for the MX801 logger with the CTD sensor. You should start the MX802 logger either before or at the same time as the MX801.
3. Confirm that the Barometric Pressure channel is On.

### Configure and Start the HOBOb MX801 Logger Using HOBObconnect

1. You may need to wake the MX801 logger using the magnetic fob. To do so, hold the magnetic fob on the WAKE icon, as shown in the previous section.
2. Configure the Logging Interval and Start Logging settings. If you are using a barometric pressure logger, use the same settings as you are using for that.
3. Tap Temperature and ensure that this is set to On. If you're recording water level, you also need to have Absolute Pressure set to On. Turn the other measurement channels on or off as desired. If you want to record Specific Conductivity, select that channel and enter the temperature compensation for the water where the logger will be deployed. If you choose to enter a Linear Compensation Value, this is typically different from the temperature coefficient of the calibration solutions. If you want to record Salinity-Adjusted DO, you will need to either have a CT or CTD sensor connected to the same logger, or you will need to enter the salinity of the water.



**Note:** The logger is able to calculate and log certain parameters without needing to log the basic measurements used to get those parameters. For example you can log salinity without having to log electrical conductivity and temperature. However, it is often a good idea to log the basic measurements in case you need those later.

### Mount and Deploy the Logger

1. Mount the MX801 logger in water at the site. See [Mount and Deploy the MX801 Logger](#) for mounting recommendations.
2. If you are logging water level, deploy the barometric pressure logger.

3. If you are logging water level, allow the MX801 logger time to reach temperature equilibrium and take a reference water level reading. Record this along with the time it was taken in your deployment notes. You will need this reference water level reading when you post-process the data in HOBObconnect.

## Download the Data

1. At the end of the deployment, we recommend taking measurements of any critical water parameters, and making notes of these values and the time they were taken. These could be useful later for data validation and data correction if necessary.
2. Pull up the logger from its deployment location.
3. In HOBObconnect, tap the MX801 tile and download data.
4. If you are redeploying the logger, clean the sensor if needed, before you deploy it again.
5. If you have also deployed a logger to record barometric pressure, download that data now using the same device for downloading data from both loggers. Process the data after you are done.

## Process the Data

### Obtain Water Level Data

1. Select the Data tab.
2. Open the MX801 data file that you just downloaded.

To derive water level, follow steps 3-9.

3. Click the Reference Water Level icon at the top right of the page.



The Water Level Assistant opens.

Water Level Assistant
✕

**Water Density**

Fresh Water Adjusted for Temp

Fresh Water (1000.000 kg/m<sup>3</sup>)

Salt Water (1025.005 kg/m<sup>3</sup>)

Brackish Water (1009.996 kg/m<sup>3</sup>)

Manual Input  kg/m<sup>3</sup>

**Reference Water Level**

Use a Reference Water Level

Water Level  m

Reference Time

Use a constant Barometric Pressure

**Barometric Data File** ⓘ

Choose No File Selected yet.

Cancel
Proceed

4. Select one of the Water Densities that are listed or enter one manually.
5. Select the Use Reference Water Level check box and enter the Reference Water Level that you recorded earlier when you deployed the logger
6. Select the Reference Time closest to the time you took the Reference Water Level measurement.
7. Select the file you are using with the barometric pressure data (or enter a fixed pressure).
8. Once you have entered the information on the screen, click Proceed. HOBObconnect will calculate the water level data channel. To save this water level data and the barometric pressure data used, you must export the data file.

Water Density	Several selections for water density, including an option to manually enter water density.
Reference Water Level	In general, you should use a reference water level. Enter the reference water level measurement that you recorded during the deployment and select the closest time to when that was taken. Typically this will be from the beginning of the deployment.
Barometric Data	In most cases, you should use a barometric pressure data file to compensate for barometric pressure changes during your deployment. Normal barometric pressure changes can otherwise result in 6" or more of error. For short deployments of less than a day with no major weather fronts coming through, it may be OK to use a constant barometric pressure.

**Notes:**

- Note that the HOBOfile exported here is not compatible with HOBOWare.
- You can choose to export and share the file. Share is available only on the mobile app. On Windows, the data files are stored in folder \Documents\HOBOfconnect; you can copy or move the files from there.
- After you process the data, you may need to click on the parameter box to see the line on the graph.

**Obtain DO Percent Saturation**

You can process the dissolved oxygen (DO) data to get DO in percent saturation using barometric pressure data from a nearby MX802 logger.

You also need to account for salinity. If salinity is constant, enter that salinity. If it is changing, use a salinity data file from the site to process the data. If you are in fresh water, salinity is zero.

1. Select the Data tab.
2. Open the MX801 data file that you just downloaded.

To derive DO Percent Saturation, follow steps 3-6.

3. Click the %DO icon at the top right of the page. The DO Assistant opens.
4. Enter either a fixed salinity or link an MX800 salinity file.
5. Enter either a fixed barometric pressure or link an MX802 or MX2001 barometric pressure data file.
6. Once you have entered the information on the screen, click Proceed. HOBOfconnect adds columns in the exported data file for the salinity, barometric pressure, and percent saturation.

**Notes:**

- Note that the HOBOfile exported here is not compatible with HOBOWare.
- You can choose to export and share the file. Share is available only on the mobile app. On Windows, the data files are stored in folder \Documents\HOBOfconnect; you can copy or move the files from there.
- After you process the data, you may need to click on the parameter box to see the line on the graph.

# HOBO MX802 Direct Read Logger Quick Start Guide

## Overview

The HOBO MX802 Direct Read Logger is designed to be used with compatible HOBO W-Series sensors to log water parameters such as conductivity, temperature, depth and more.

This logger is typically deployed with the sensor connected via direct-read cable. The sensor remains in the water while deployed and the logger is above the water for convenient wireless Bluetooth readout. The MX802 is weatherproof but not waterproof, so it must be mounted in such a way so that it remains above the water. The cables must be attached to the sensors for them to be waterproof and attached to the logger for that to be weatherproof.

If you are using this logger with two sensors, you will need to use the 2-sensor adapter. See the manual that comes with that adapter for attaching the two sensors.

The following is an overview of the steps for configuring and deploying the logger:

1. [Connect the Sensor](#)
2. [Calibrate the Sensor](#)
3. [Mount and Deploy the Logger](#)
4. [Configure the Logger](#)
5. [Download the Data](#)



**Note:** If you are using either a W-CTD or W-CT sensor and it has not been in water, we recommend attaching the cable and sensor to the MX802 logger and soaking the sensor in tap water for 24 hours before performing a conductivity calibration.

## Connect the Cable and Sensor to the Logger

1. Take the rubber cap off the end of the logger.
2. Connect the cable to the logger by aligning the alignment pin on the cable connector with the alignment hole on the logger connector. Do not force the connection because you do not want to bend any of the pins.



**Important:** When assembling the logger or attaching the cable, make sure the o-rings and cable connector surfaces are clear of any debris and that the o-rings are lightly lubricated. Any contamination on these surfaces can cause leaks that lead to logger failure. The loggers and cables come from the factory with the proper amount of lubricant.



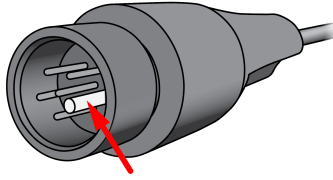

3. Attach the tapered coupler over the connection between the cable and the logger. To do so, ensure that the magnetic fob is attached to one half of the tapered coupler. Snap one side of the coupler over the connection between the cable and the logger with the tapered end toward the cable. Slide the other half of the tapered coupler over the connection and press the two parts together; listen for a snap. The fob should be able to slide into its home when the pieces are together. See the following illustrations.

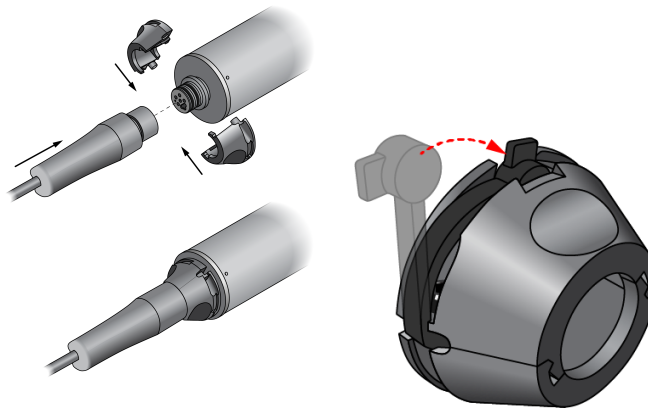

4. Tighten the tapered coupler screws with the allen wrench that is included with the logger. You may need to move the magnetic fob out of the way.
5. Insert the magnetic fob into its holding spot on the coupler.
6. Remove the protective cap from the other end of the cable.
7. Align the alignment pin and connect the end of the cable to the sensor in the same manner as you did above.
8. Use the straight coupler that comes with the cable to lock the connection between the cable and the sensor. There are two coupler halves that snap together over the connection. Install the half with the pins first, and then snap on the other half.

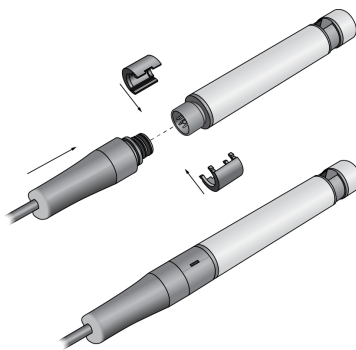

**Note:** It is normal for there to be a small gap between the coupler and the logger, sensor, or cable. Note also that it is normal for the couplers to rotate around the connection. This allows you to rotate the magnetic fob to where you can easily reach the magnet icons for activating logger functions.

### Install the Sensor Cap (DO Sensor only)

If you are using a DO sensor, you must install the DO sensor cap. The sensor is not waterproof without the cap. See [Set up the DO Sensor](#).

### Download and open HOBObconnect

You need to use HOBObconnect with the HOBOb MX Series loggers. To download HOBObconnect go to:

[www.onsetcomp.com/products/software/hobobconnect](http://www.onsetcomp.com/products/software/hobobconnect)

### Calibrate the Sensor

If you are using CTD, CT, or DO sensors, calibrate them in your office or lab before configuring the loggers for deployment. The HOBObconnect app guides you through the basic calibration steps. To achieve the best calibration accuracy, refer to [Conductivity Sensor Calibration](#) or [DO Sensor Calibration](#).

### Mount and Deploy the Logger

1. Deploy the MX802 at the site with the sensor in the water and the logger above the water. See [Mount and Deploy the MX802 Logger](#) for mounting recommendations. Make sure the logger is mounted high enough so that it will not get flooded.
2. If you are logging water level, use HOBObconnect to enter the current water level by first selecting the logger's tile and clicking the Reference Water Level button. Make sure that the CTD sensor has had enough time to reach temperature equilibrium when you enter the Reference Water Level. Enter the Water Density as well.

## Configure and Start the HOBOMX802 Logger Using HOBOMconnect

1. Select the logger's tile and then select Customize Configuration & Start to configure the Logging Interval and Start Logging settings. To make the tile appear, you may need to wake the logger using the magnetic fob. To do so, hold the magnetic fob on the WAKE magnet icon as shown in the following illustration.

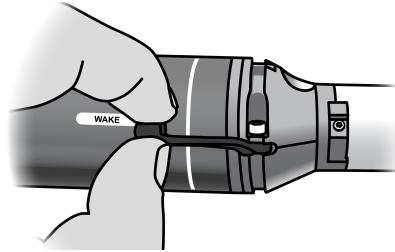

2. Turn the other measurement channels on or off as desired. If you want to record Specific Conductivity, enter the temperature compensation for the water where the logger will be deployed. If you choose to enter a Linear Compensation Value, this is typically different from the temperature coefficient of the calibration solutions. If you want to record Salinity-Adjusted DO, you will need to either have a CT or CTD sensor connected to the same logger, or you will need to enter the salinity of the water.



**Note:** The logger is able to calculate and log certain parameters without needing to log the basic measurements used to get those parameters. For example you can log salinity without having to log electrical conductivity and temperature. However, it is often a good idea to log the basic measurements in case you need those later.

## Download the Data

1. At the end of the deployment, we recommend taking measurements of any critical water parameters, and making notes of these values and the time they were taken. These could be useful later for data validation and data correction if necessary.
2. In HOBOMconnect, tap the MX802 tile and download data.

### Notes:

Note that the HOBOMfile exported here is not compatible with HOBOMware.

You can choose to export and share the file. Share is available only on the mobile app. On Windows, the data files are stored in folder \Documents\HOBOMconnect; you can copy or move the files from there.

# HOBO MX800 Series User Guide

## Logger Components and Operation

The following image shows the MX801 logger and a CTD sensor.

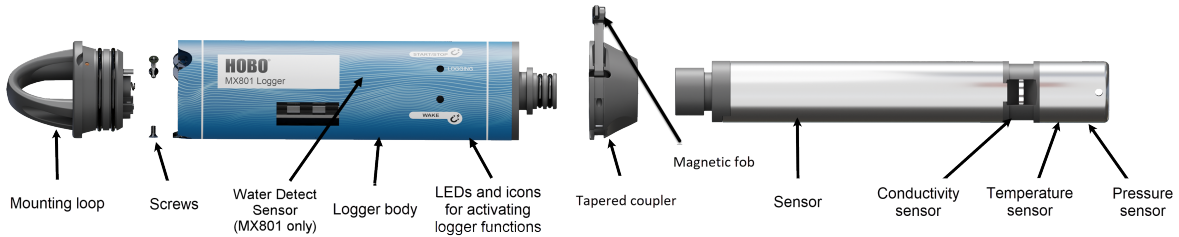

The following image shows the DO sensor and its protective sensor guard in place.

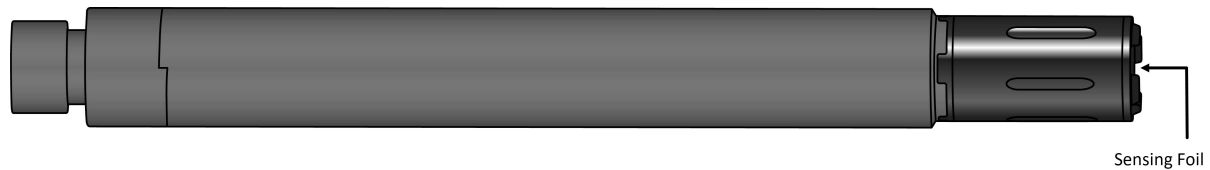

The following image shows the vent hole for the barometric sensor on the end of the MX802.

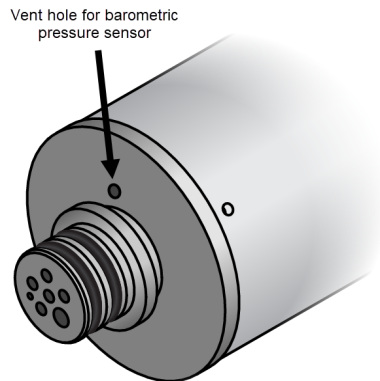

**Mounting loop:** This cap is attached with screws to the logger body. Remove it to replace the batteries.

**Screws:** These three screws are removable and allow you to replace the battery.

**Logger Body:** The main body of the logger.

**Icons & LEDs:** The images that show you where to hold the magnetic fob and the LEDs that show you the state of the logger. The LOGGING LED blinks every 4 seconds when the logger is logging (unless Show LED is disabled as described in [Configure Logger Operation](#)). The WAKE LED blinks multiple times when you hold the magnetic fob on the WAKE icon to wake up the logger. If you select Illuminate Logger in the app, both LEDs are illuminated for 5 seconds.

**Tapered coupler:** The tapered piece that connects the logger to the sensor or cable. Contains the magnetic fob.

**Sensor:** The sensor attaches to the logger using the tapered coupler or to the cable with the straight coupler.

**Conductivity Sensor:** The conductivity sensor electrodes are visible at this break point in the sensor.

**Temperature Sensor:** The temperature sensor is located about half way between the pressure sensor and the conductivity sensor. It is not visible.

**Pressure Sensor:** The pressure sensor is located about one third of an inch (8mm) from the end of the sensor. It is not visible.

## Set up the DO Sensor

The DO sensor comes with a DO sensor cap in a separate container. The DO sensor and sensor cap require some minimal set up before they are ready to deploy. You must install that cap before you can use the sensor.

1. Remove the calibration boot, which is a black rubber covering on the end of the sensor when it is shipped to you.
2. In addition, unscrew the sensor guard, which may also remove the red cover with it. If the red cover does not come off, remove it by hand by tugging gently on it. You can dispose of the red cover as that is only needed to protect the sensor window when there is no sensor cap.

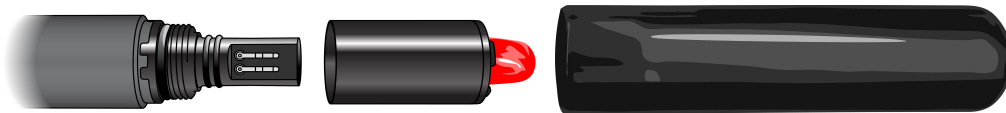

3. Separately, remove the sensor cap from its packaging, being sure not to touch its end, which is the optical sensing foil. Pull the sensor cap off the inside of the lid.
4. Match the lines on the cap with the electrodes on the sensor and gently push the cap onto the end of the sensor, as shown in the following image. It is normal for it to push backward or to pop off due to air pressure.

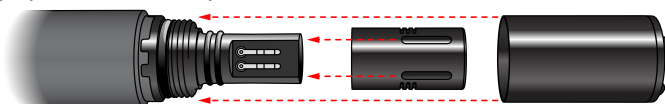

5. Replace the sensor guard over the sensor cap and screw it back in place, again, being careful not to touch the end of the sensor cap.

## Configure Logger Operation

Use the HOBOnnect app to set up the logger, including selecting the logging options, configuring alarms, and other settings. The following table provides brief information on the available settings. For more information, see the [HOBOnnect User Guide](#).



Note: Calibrate your CT, CTD, or DO sensors before configuring them. For more information, see [Conductivity Sensor Calibration](#) or [DO Sensor Calibration](#).

To configure the logger:

1. Hold the magnet on the fob over the WAKE icon to wake up the logger.
2. Tap Devices and then tap the logger tile in HOBOnnect to connect to the logger.
3. Tap Customize Configuration & Start to configure the logger.
4. Establish your settings. See the table below for descriptions of the fields.
5. Tap Start to save the configuration settings. Logging begins based on the settings you select. See [Mount and Deploy the MX801 Logger](#) or [Mount and Deploy the MX802 Logger](#) for details on mounting and see [Download Data From the Logger](#) for details on downloading.

### Logger Name and Group

Logger Name	A name for the logger (optional). If you do not enter a name, the app uses the logger serial number as the name.
Logger Group	The group that the logger belongs to (optional). Select an existing group or add a new one.

### Logger Settings

Logging Interval	Determines how frequently the logger records data unless the logger is in burst logging mode (see <a href="#">Burst Logging</a> ). <b>Note:</b> If you configure alarms, the logger uses the logging interval you select as the rate to check for alarm conditions (alarms are not available in burst logging mode). See <a href="#">Set up Alarms</a> for more details.
Add Interval	Adding an interval allows you to log at one logging interval for a time period and then at another logger interval for the next time interval, for up to 8 time periods. It allows you to repeat a logging interval sequence or set a pause, which allows you to take a collection of readings at regular intervals. For example, you can have the logger log at 5 seconds for 1 minute, and then Pause logging for 5 minutes. Then, it will repeat this sequence until the memory is full or the logger is stopped. While the logger is Paused in this mode, it does not log any readings.
Logging Capacity	A read-only field that reports to you the approximate number of days the memory will

	last based on the selected logging interval and number of channels being logged.
Start Logging	<p><b>On Save.</b> Logging begins immediately after you save the configuration settings.</p> <p><b>On Next Interval.</b> Logging begins at the next even interval as determined by the selected logging interval. Use this option if you want the timestamps to be on even times, such as 10:00, 10:05, 10:10, etc.</p> <p><b>On Button Push.</b> Logging begins when you hold the magnet on the Start/Stop magnet icon on the logger for 3 seconds or start logging with the app.</p> <p><b>On Date/Time.</b> Logging begins at a date and time you specify. Select the Date and Time.</p>
Stop Logging	<p><b>Never Stop (Overwrites Old Data).</b> Logging does not stop. The logger continues recording data indefinitely. The newest data overwrites the oldest.</p> <p><b>On Date/Time.</b> Logging stops on a specific date and time that you specify.</p> <p><b>After.</b> Logging stops after an amount of time you specify. Choose the amount of time you want the logger to log data. For example, select 30 days if you want the logger to log data for 30 days after logging begins.</p> <p><b>Stop When Memory Fills.</b> Logging continues until the memory is full.</p>
Pause Options	<p><b>Pause on Button Push</b> Allows you to stop logging by holding the magnetic fob on the Start/Stop magnet icon on the logger.</p> <p><b>Allow Button Resume</b> Allows you to pause and resume logging by holding the magnetic fob on the Start/Stop magnet icon on the logger.</p>
Logging Mode	<p><b>Fixed Logging Mode.</b> The logger records data for enabled sensors and selected statistics at the logging interval specified.</p> <p><b>Burst Logging Mode.</b> The logger records data for enabled sensors at the fixed logging interval until the readings rise above or fall below specific limits, at which time the logger switches to a faster burst logging rate until the readings return to normal. See <a href="#">Burst Logging</a> for more information</p> <p><b>Statistics.</b> The statistics you want the logger to record for all enabled sensors at each logging interval. See <a href="#">Statistics Logging</a> for more information.</p> <p><b>Note:</b> Sensor values are automatically recorded in fixed logging mode; use statistics to log additional statistics that you may require.</p>
Show LED	Toggles whether the LEDs on the logger are visible during logging.

## Set a Password

You can create an encrypted password for the logger that is required if another device attempts to connect to it. This is recommended to ensure that a deployed logger is not mistakenly stopped or purposely altered by others. This password uses a proprietary encryption algorithm that changes with every connection.

Only the device used to set the password can then connect to the logger without entering a password; all other devices are required to enter the password. For example, if you set the password for the logger with your tablet and then try to connect to the logger later with your phone, you must enter the password on the phone but not with your tablet. Similarly, if others attempt to connect to the logger with different devices, they are also required to enter the password.

## Reset the Password

To reset a password:

1. Hold the fob on the WAKE magnet icon for ten seconds. Or, you can also connect to the logger with HOBObconnect, tap Manage Password, and tap Reset. Both options remove the current password and resets it to the factory default, which is no password.
2. Tap Lock Logger to enter a new password.

## Statistics Logging

In Fixed Logging Mode, the logger records data for enabled sensors and/or selected statistics at the logging interval selected. Readings are taken at a sampling rate you specify with the results for the sampling period recorded at each logging interval. You can log the following statistics for each sensor:

- The maximum, or highest, sampled value
- The minimum, or lowest, sampled value
- An average of all sampled values
- The standard deviation from the average for all sampled values

For example, a logger is configured with the logging interval set to 5 minutes in Fixed Logging Mode. In addition, all four statistics are enabled with a statistics sampling interval of 30 seconds. Once logging begins, the logger measures and records the actual temperature values every 5 minutes. In addition, the logger takes a temperature sample every 30 seconds and temporarily stores it in memory. The logger then calculates the maximum, minimum, average, and standard deviation using the samples gathered over the previous 5-minute period and logs the resulting values.



To log statistics:

1. Select Fixed Logging Mode.
2. Turn Statistics On and select the statistics you want the logger to record at each logging interval: Maximum, Minimum, Average, and Standard Deviation (average is automatically enabled when selecting Standard Deviation). Statistics are logged for all enabled sensors. In addition, the more statistics you record, the shorter the logger duration and the more memory is required.
3. Tap Statistics Sampling Interval and select the rate to use for taking readings. The rate must be less than, and a factor of, the logging interval. For example, if the logging interval is 1 minute and you select 5 seconds for the sampling rate, the logger takes 12 sample readings between each logging interval (one sample every 5 seconds for a minute) and uses the 12 samples to record the resulting statistics at each 1-minute logging interval. Note that the faster the sampling rate, the greater the effect on battery life. Because measurements are being taken at the statistics sampling interval throughout the deployment, the battery usage is similar to what it would be if you had selected this rate for the normal logging interval.

## Burst Logging

Burst logging is a logging mode that allows you to set up more frequent logging when a specified condition is met. For example, a logger is recording data at a 5-minute logging interval and burst logging is configured to log every 30 seconds when the temperature falls below 32°F (the low limit) or rises above 85°F (the high limit). This means the logger records data every 5 minutes as long as the temperature remains between 32°F and 85°F. If the temperature falls below 32°F, then the logger switches to burst logging mode and records data every 30 seconds. Once the temperature rises back to 32°F, the logger then returns to fixed mode, logging every 5 minutes. Similarly, if the temperature rises above 85°F, the logger switches to the faster logging rate and records data every 30 seconds until the temperature falls back to 85°F. At that time, logging then resumes every 5 minutes at the fixed logging interval.



**Note:** Sensor alarms, statistics, and the Stop Logging option Never Stop (Overwrites Old Data) are not available in burst logging mode.

Burst Logging Interval	
H, M, S	The rate of logging during burst logging.
Logging Parameter	
Low	Sets the threshold, below which logging happens at burst logging rate.
High	Sets the threshold, above which logging happens at burst logging rate.

**Notes:**

- The high and low burst limits are checked at the burst logging interval rate whether the logger is in normal or burst condition. For example, if the logging interval is set to 1 hour and the burst logging interval is set to 10 minutes, the logger always checks for burst limits every 10 minutes.
- If high and/or low limits have been configured for more than one sensor, then burst logging begins when *any* high or low condition goes out of range. Burst logging does not end until all conditions on all sensors are back within normal range.
- The actual values for the burst logging limits are set to the closest value supported by the logger. In addition, burst logging can begin or end when the sensor reading is within the specified resolution. This means the value that triggers burst logging may differ slightly than the value entered.
- Once the high or low condition clears, the logging interval time is calculated using the last recorded data point in burst logging mode, not the last data point recorded at the fixed logging rate. For example, the logger has a 10-minute logging interval and logged a data point at 9:05. Then, the high limit is surpassed and burst logging begins at 9:06. Burst logging then continues until 9:12 when the sensor reading falls back below the high limit. Now back in fixed mode, the next logging interval is 10 minutes from the last burst logging point, or 9:22 in this case. If burst logging had not occurred, the next data point would have been at 9:15.
- A New Interval event is created each time the logger enters or exits burst logging mode. See [Logger Events](#) for details on plotting and viewing the event. In addition, if you stop the logger while in burst logging mode, a New Interval event is automatically logged and the burst condition is cleared, even if the actual high or low condition has not cleared.

## Set up Alarms

You can set up alarms for the logger so that if a sensor reading rises above or falls below a specified value, the red logger LED blinks and an alarm icon appears in the app. Alarms alert you to problems so you can take corrective action. The Alarm Settings area allows you to determine how long the alarms should be active. In addition, each parameter that you are logging allows you to set alarm limits for it.

## Alarm Settings

Show Visual Alarms Until	<b>Logger is Reconfigured</b> The alarms continue until you reconfigure the logger. <b>Sensors in Limits</b> The alarms continue until the sensor reading falls within the set alarm limits. <b>Alarm Button is Pressed</b> The alarms continue until you hold the fob on the WAKE magnet icon.
--------------------------	---

### For Each Parameter

Low	The bottom limit for the sensor reading. The alarm is triggered when the reading goes below this limit.
High	The top limit for the sensor reading. The alarm is triggered when the reading goes above this limit.
Duration	Set the hours and minutes that should elapse with readings exceeding the limit before the alarm trips.
Cumulative Samples	The alarm trips once the sensor reading is out of the acceptable range for the selected duration any time during logging. For example, if the high alarm is set to 85°F and the duration is set to 30 minutes, the alarm trips once the sensor readings have been above 85°F for a total of 30 minutes since the logger was configured.
Consecutive Samples	The alarm trips once the sensor reading is out of the acceptable range continuously for the selected duration. For example, the high alarm is set to 85°F and the duration is set to 30 minutes, the alarm trips only if all sensor readings are 85°F or above for a continuous 30-minute period.

When an alarm trips, an alarm icon appears in the app, and an Alarm Tripped event is logged. The alarm state clears when the readings return to normal if you selected Sensor in Limits or you wave the fob in front of the magnet. Otherwise, the alarm state remains in place until the logger is reconfigured.

### Notes:

- HOBObconnect checks alarm limits at every logging interval unless you have turned on burst logging. For example, if the logging interval is set to 5 minutes, the logger checks the sensor readings against your configured high and low alarm setting every 5 minutes.
- The actual values for the high and low alarm limits are set to the closest value supported by the logger. For example, the closest value to 85°F that the logger can record is 84.990°F. In addition, alarms can trip or clear when the sensor reading is within the specified resolution specifications.
- When you read out the logger, alarm events can be displayed on the plot or in the data file. See [Logger Events](#).

## Select Which Channels to Log

You can determine which channels are collecting data by turning them on and off. To do so:

1. Select Devices and select the tile for the logger.
2. Select Customize Configuration & Start.
3. Select the parameter that you want to turn on or off.
4. On the right side of the page turn Enable Logging on or off.

### Notes:

- The logger can calculate and log certain parameters without needing to log the basic measurements used to get those parameters. For example you can log salinity without having to log electrical conductivity and temperature. However, it is often a good idea to log the basic measurements in case you need those later.
- If you're recording water level, you also need to have Absolute Pressure set to On.
- If you want to record Specific Conductivity, select that channel and enter the temperature compensation for the water where the logger will be deployed. See below.
- Note that the parameters include the sensor model and serial number so you can confirm you are turning off the sensor channel that you intended to turn on or off.
- This is also how you select a sensor for assigning it a name and to enable alarms.
- You can also view the current conductivity calibration points under Electrical Conductivity.
- For Total Dissolved Solids, you can enter the TDS Constant.
- If you want to record Salinity-Adjusted DO, you must have a CT or CTD sensor connected to the same logger or you must enter the salinity of the water.

## Set the Specific Conductivity Temperature Compensation Value

If you are logging Specific Conductivity, you will need to select a temperature compensation method as described below.

1. Tap Devices and then tap the tile of the logger you are using.
2. Tap Customize Configuration & Start.
3. Tap Specific Conductivity on the left.
4. Select a temperature compensation method. For freshwater you should generally use the Non-Linear, Freshwater Compensation method. For saltwater, you should use Linear Compensation and enter a temperature compensation value (aka temperature coefficient) for the water at your site. If you don't know the temperature coefficient, 2.1%/°C is commonly used for saltwater.



**Note:** Once you've entered the Temperature Compensation value for the water at your site, and if you then put that logger in calibration solution, it will not be the correct Temperature Compensation value for the calibration solution. This means that you will not get the specific conductance values you would expect.

## Mount and Deploy the MX801 Logger

The submersible HOBO MX801 Logger is designed to be easy to deploy in many environments. It does not need a cable connecting it to a logger at the surface. The CTD sensor uses an absolute pressure sensor, so no vent tube is required. The submersible logger and sensor can be easily mounted and/or hidden in the field. Follow these guidelines when deploying the logger:

- Make sure the sensor is attached to the logger and that it is calibrated before going to the deployment site.
- Generally, for deployment in wells, we recommend using the MX802 because it can also log barometric pressure. However, it is fine to use MX801 loggers in wells, too. When deploying a MX801 with a CTD sensor in a well, make sure the well is vented to the atmosphere. Typically, you can drill a small hole in the well cap to ensure that the pressure inside and outside the well is at equilibrium. If this is not possible, use the MX802 logger with a cable to the sensor.
- Use a no-stretch wire such as teflon-coated stainless steel wire to hang the logger in a well. Any change in length of the wire will result in a 1-to-1 corresponding error in the depth measurement. Always pull-test a cable prior to deploying a logger in a well to make sure it does not stretch. You will also need a way to attach the cable at the top of the well. For 2" wells, you can use Onset's well cap (WELL-CAP-01) which includes a mounting disc for attaching the cable.
- If you are deploying the logger in a lake, river, or stream, we recommend deploying the logger in a protective housing to protect the logger from wave action, shock, debris and movement. You can use Onset's protective housing (HOUSING-1) or make your own with PVC or ABS pipe. You will need to secure the logger and sensor in the housing so that they do not move. This is important for protecting the logger and sensor, as well as to ensure accurate water level measurements. Mount the protective housing to a rock or cement block or something else that will not move. Mount it so the logger is always underwater, but not on the bottom to be buried by silt. For more information on building a stilling well, see the Technical Application Note for Constructing a Stilling Well at:
  - <https://www.onsetcomp.com/resources/tech-notes/how-to-build-stilling-well>
- To prevent loggers suspended on cables from moving in currents and to ensure the support cable is kept straight during deployment, you may need to add a weight to the suspension cable or hang a weight below the logger. Alternatively, you could deploy the logger in a stilling well as described above.

- Be very careful not to exceed the burst pressure for the logger. The pressure sensor will burst if the maximum depth is exceeded (see specifications table). The logger should be positioned at a depth where the logger will remain in the water for the duration of the deployment, but not exceed the rated bursting depth.

## Deploy the MX801 Logger

To suspend the logger in a well:

1. Start the logger if you have not already started it.
2. Lower the logger into to its deployment location.
3. Measure the reference water level from the desired reference point (top of well, bottom of stream, etc.) following the guidelines provided in the section on taking reference water level measurements.
  - To maximize accuracy, allow 5 minutes after deploying the logger before measuring water depth to allow the logger to reach temperature equilibrium with the water.
  - If the well is too small in diameter to measure the water depth after deployment, measure the water depth before deployment, then deploy the logger immediately and record deployment time.

## Mount and Deploy the MX802 Logger

The HOBO MX802 is weatherproof, but not waterproof. Mount the HOBO MX802 logger above the water so that it can log barometric pressure. There is a vent with a hydrophobic membrane that allows the logger to sense barometric pressure while keeping water out. The membrane on the vent can withstand splashing but should not be submerged. The vent membrane keeps out most moisture, but deploying this logger in a continuous, highly saturated well environment can eventually lead to condensation inside the logger. This can be further worsened by extreme temperature cycling, such as wells that are in direct sun and shallow water tables that are close to the logger.

Adequate air flow is required to ensure condensation is minimized on and around the MX802. The vent for the barometric pressure sensor is in the end of the logger where the cable connects.



## Wells with Normal Humidity Levels

For wells with normal outdoor humidity levels, drill a small vent hole in the side of the well cap to ensure that the pressure inside and outside the well is at equilibrium. You can also use the Onset well cap (WELL-CAP-01).

## Wells with Sustained High Humidity Levels

For wells with sustained levels of high humidity, you will need to either find a way to reduce the humidity around the logger, or mount the logger outside the well. To reduce the humidity in the well, you can drill two holes on opposite sides of the well in the area by the barometric sensor vent to create cross circulation. To mount the logger outside the well, you will need a way to route the sensor cable from the well, such as the Onset well cap for cabled sensors (WELL-CAP-02).

- If you are mounting the MX802 outside the well, make sure it is shaded so that it is never in direct sun (the temperature extremes caused by being in the direct sun will reduce the accuracy).
- If you are deploying the logger in a 5 cm (2 inch) diameter well, use the Onset well cap (WELL-CAP-01) to suspend the logger and sensor in the well.

If your well must remain sealed and there is no way to avoid a continuous saturated environment, use non-vented water level loggers, such as the HOBO U20 or U20L water level loggers.

## Other Well Mounting Considerations

In addition, follow these guidelines when deploying the MX802 logger in a well:

- Make sure the sensor and cable are attached to the logger and the sensor is calibrated before going to the deployment site.
- If you are not using an Onset well cap, consider using slots for a mounting bolt used to suspend the logger at the top of the well rather than holes so that the logger can be pulled up easily for well access without having to remove nuts in the field. This can reduce the chances for small parts falling into the water and being lost.
- The top of the logger must be close to the top of the well and not shielded in metal so that your mobile device or computer can connect to it. The maximum range for communication is 30.5m (100 ft) with full line-of-sight.
- If you are deploying the logger in a lake, river, or stream, you must first build a stilling well to protect the logger, sensor, and cable. A simple stilling well can be constructed with PVC or ABS pipe. A properly constructed stilling well holds the sensor in position and protects the logger components from currents, wave action, and debris. Suspend the sensor in the stilling well so it is always underwater, but not on the bottom to be buried by silt. For more information, see the Technical Application Note for Constructing a Stilling Well at:
  - <https://www.onsetcomp.com/resources/tech-notes/how-to-build-stilling-well>

## Deploy an MX802 for Barometric Pressure Data (Optional)

- If you are using an MX802 logger to record barometric pressure data for use with MX801 logger data, it must either have a cable and sensor attached or a termination plug (W-PLUG) attached to it to make it weatherproof.
- If you are using the barometric pressure data to get dissolved oxygen data in percent saturation, the MX802 should be nearby the location of the logger recording dissolved oxygen.



- If you are using the barometric pressure data for water level, it can be within 10 miles of the MX801 logger recording water pressure. This means that you can use one logger recording barometric pressure data with many loggers recording water pressure.
- Deploy the barometric pressure logger in the shade, because rapid temperature changes from heating in the sun can result in measurement error.
- It is best to start your barometric pressure logger before starting your loggers recording dissolved oxygen or water pressure. This is because the data assistants can only calculate water level or DO percent saturation for times it has barometric pressure data.

## General Guidelines for Mounting the MX802 Logger

- The sensor is located on the end of the device and needs to be in the water to measure water level.
- Any change in length of the logger cable will result in a 1-to-1 corresponding error in the depth measurement. Always pull-test a cable prior to deploying a logger in a well to make sure it does not stretch.
- To prevent the sensor from moving in currents and to ensure the support cable is kept straight during deployment, you may need to add a weight to the suspension cable just above the sensor or hang a weight below the sensor.
- Be very careful not to exceed the burst pressure for the sensor. The pressure sensor will burst if the maximum depth is exceeded (see [HOBO MX801/802 Specifications](#)). The sensor should be positioned at a depth where it will remain in the water for the duration of the deployment, but not exceed the rated bursting depth.
- If the environment where you are deploying the logger is known to have ants that are attracted to electronics, take appropriate protective measures to protect the logger, such as using pesticides. Ants have been known to eat through barometric pressure sensor vent membranes. When this happens, moisture may enter the logger.
- Avoid deploying the logger in direct sun as that can lead to more rapid temperature swings, which can lead to more measurement error and possibly hurt logger reliability.
- The logger must be above any metal well to ensure good wireless transmission.
- Make sure there is access for measuring the water level in the well. In some cases, such as when using the Onset well cap, it will be necessary to pull the logger out of the well to get a water level meter sensor into the well.
- Make sure the logger cannot accidentally fall in the well.
- If the cable is too long, loop the cable and secure the cable with 3 or 4 cable ties to ensure the loop does not slip. The looped cable should be tight enough that the cable can be easily pulled out of the well if necessary, but it must not bend the cable any tighter than a 1.25 cm (0.5 inch) radius to prevent damage to the cable.



## Deploy the MX802 Logger

To obtain the highest level of accuracy, both the sensor and logger should be allowed to come to full temperature equilibrium before you make your reference water level measurement and enter it into HOBObconnect. The sensor takes approximately 5 minutes and the logger takes approximately 20 minutes.

To deploy the logger:

1. Make sure the logger is connected to the sensor end as described in [Connect the Cable and Sensor to the Logger](#) for the MX802.
2. If you are using the Onset well cap, make sure that the logger is secured to the mounting disk.
3. Gently lower the logger into the well.

## Take Reference Water Level Measurements (MX801 and MX802)

The reference water level measurement shifts your water level data to use a reference point that is meaningful in your application. It also corrects for any offset errors in your sensors. For MX802 loggers, enter the reference water level while the sensor is deployed in location, but before the logger is configured and started. For the MX801 logger, enter the reference water level and the time it was taken into your field notes. Later, enter them into the water level data assistant when post-processing the data.

Measure the water level from the desired reference point (top of pipe, ground level, or sea level). Note that you may need to pull the top end out of the well to gain access for measuring the water level within the well. Follow these guidelines for determining the reference level:

- If the well is too small in diameter to measure the water depth while the logger is deployed, measure the water depth before deployment, then deploy the logger immediately.

- If the water level surface is below the reference point as shown below, enter the reference water level in the app as a negative number.

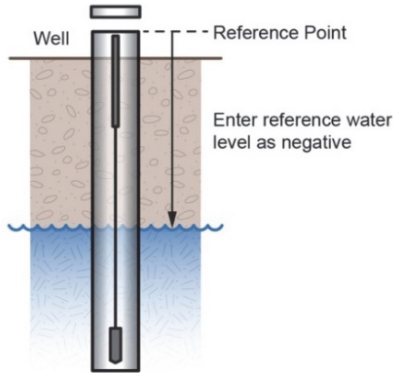

- If the water level surface is above the reference point as shown below, enter the reference water level in the app as a positive number.

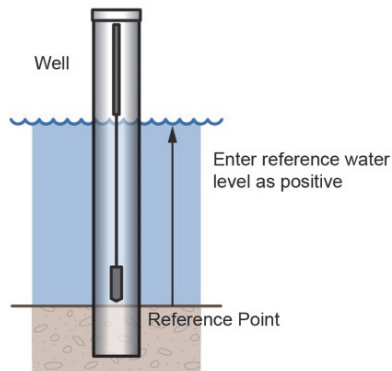

- If you are using the sensor as the reference point as shown below, enter the reference water level in the app as zero for a time before the sensor is in the water. The logged water level readings will represent the height above the sensor.

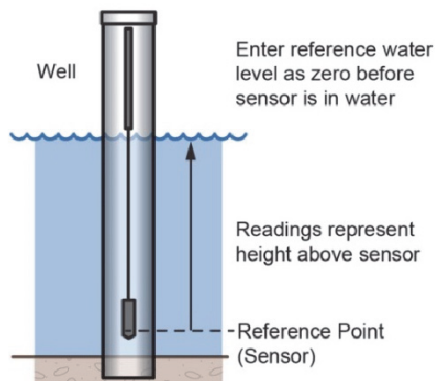

## Download Data From the Logger

Before downloading the data, we recommend taking field measurements of important parameters such as water level and conductivity in case you need these for adjusting data later. Take these readings next to the loggers, along with the time they were taken so that they can be directly compared to the readings logged at that time.

To download data from the logger:

1. Tap Devices and select the logger tile for the logger whose data you want to download.
2. Tap Download Data. The logger downloads data to the phone, tablet, or computer.
3. Once the download is complete, tap Done to return to the previous page or tap Export and Share to save the file in the specified format.

You can also upload data automatically to HOBOLink, Onset's web-based software, using the HOBOLink connect app. For details, see the [HOBOLink User Guide](#) and see the HOBOLink help for details on working with data in HOBOLink.



**Note:** This logger does not currently support the ability to upload its data to HOBOLink; It will support this feature in the future.

## Post-Processing Data to Extract Other Parameters

### Obtain Water Level Data

Use the Water Level Assistant to obtain water level data by entering the water density, reference water level, and linking a barometric pressure data file.

1. Select the Data tab.
2. Open the MX801 data file that you just downloaded.

To derive water level, follow steps 3-9.

3. Click the Reference Water Level icon at the top right of the page.



The Water Level Assistant opens.

Water Level Assistant
×

**Water Density**

Fresh Water Adjusted for Temp

Fresh Water (1000.000 kg/m<sup>3</sup>)

Salt Water (1025.005 kg/m<sup>3</sup>)

Brackish Water (1009.996 kg/m<sup>3</sup>)

Manual Input  kg/m<sup>3</sup>

**Reference Water Level**

Use a Reference Water Level

Water Level  m

Reference Time

Use a constant Barometric Pressure

**Barometric Data File** ⓘ

Choose *No File Selected yet.*

Cancel
Proceed

4. Select one of the Water Densities that are listed or enter one manually.
5. Select the Use Reference Water Level check box and enter the Reference Water Level that you recorded earlier when you deployed the logger
6. Select the Reference Time closest to the time you took the Reference Water Level measurement.
7. Select the file you are using with the barometric pressure data (or enter a fixed pressure).
8. Once you have entered the information on the screen, click Proceed. HOBObconnect will calculate the water level data channel. To save this water level data and the barometric pressure data used, you must export the data file.

Water Density	Several selections for water density, including an option to manually enter water density.
Reference Water Level	In general, you should use a reference water level. Enter the reference water level measurement that you recorded during the deployment and select the closest time to when that was taken. Typically this will be from the beginning of the deployment.
Barometric Data	In most cases, you should use a barometric pressure data file to compensate for

barometric pressure changes during your deployment. Normal barometric pressure changes can otherwise result in 6" or more of error. For short deployments of less than a day with no major weather fronts coming through, it may be OK to use a constant barometric pressure.

**Notes:**

- Note that the HOBOfile exported here is not compatible with HOBOWare.
- You can choose to export and share the file. Share is available only on the mobile app. On Windows, the data files are stored in folder \Documents\HOBOfconnect; you can copy or move the files from there.
- After you process the data, you may need to click on the parameter box to see the line on the graph.

## **DO Percent Saturation Assistant**

In development.

## **Maintain the Logger and Sensors**

### **Clean the Logger**

Periodically inspect the logger for fouling. To clean the logger housing, rinse the logger in warm water, making sure that a sensor or cable is attached. With the MX802 logger, avoid getting water in the vent for the barometric pressure sensor. Use mild dish soap if necessary on the logger housing only. Do not use harsh chemicals, solvents, or abrasives.

### **Clean the Conductivity Sensors on the W-CTD and W-CT Sensors**

To clean the conductivity sensor, remove the anti-fouling guard. See [Use an Anti-Fouling Guard](#) for more information.

Clean the conductivity sensor using a soft dental brush such as the one in the following image. Gently clean between the electrodes and the plastic areas around the electrodes with the dental brush to remove fouling. Do not use metal, plastic bristle brushes, or sharp tools.



### **Cleaning the DO Sensor**

To clean the sensor cap:

1. Remove the anti-fouling guard if present, but leave the sensor cap on the sensor. If you are using the protective guard, leave that on for cleaning.

2. Gently wipe the cap with a soft-bristled brush (such as a toothbrush) or soft cloth if biofouling is present. Use Alconox® to remove grease.
3. If extensive debris or mineral build-up is present, soak the cap end in vinegar for 15 minutes, then soak it in deionized (DI) water for another 15 minutes.
4. When storing the logger between deployments, keep the sensor in the calibration boot (wet the small sponge with fresh water, place the sponge in the end of the calibration boot, and then insert the sensor in the boot.)



**WARNING:** Do not use organic solvents; they will damage the sensor. Do not remove the sensor cap from the sensor prior to cleaning with a brush.

To clean the sensor body:

1. Make sure the sensor cap is installed on the sensor.
2. Gently scrub the sensor body with a plastic bristle brush or nylon dish scrubber.
3. Use Alconox® to remove grease.
4. Soak in vinegar to remove mineral deposits.
5. Rinse with deionized (DI) water.

## Replace the Batteries

The logger uses 4 AA lithium batteries. You will need to replace them every 1 to 2 years based on the sensors you are using and the logging rate.

To replace the batteries:

1. Stop the logger if it is still logging.
2. Download any data from the logger. Data is retained during the batter replacement, so you can download it after if you prefer.
3. Using a 2mm allen wrench, remove the three allen screws that hold the mounting loop and pull it off the logger.
4. Remove the batteries from the logger, paying special attention to remember the orientation of the batteries' polarity.
5. Insert new batteries the same way the spent batteries were installed.
6. Replace the mounting loop and its screws. **Note:** Be sure that there is no debris on the o-rings or mating surface. The o-rings should have a lite coating of o-ring lube. Any contamination on the o-ring seal could lead to water entry and logger failure.

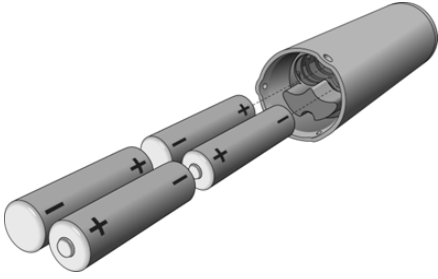

## Change the Sensor on the MX801

To change the sensor attached to the MX801 logger:

1. Stop the logger if it is still running.
2. Download any data from the logger.
3. Using the 3/32" allen wrench included with your logger, remove the tapered coupler from the logger and detach the sensor by pulling it straight out. (Do not twist.)
4. To connect a sensor to the logger, refer to [Connect a Sensor to the Logger](#).

## Change the Sensor and Cable on the MX802

### Change the Cable on the MX802

To change the cable attached to the MX802 logger:

1. Stop the logger if it is still running.
2. Download any data from the logger.
3. Using a 3/32" allen wrench (originally included with your logger), remove the tapered coupler from the logger.
4. Detach the cable by pulling it straight out. (Do not twist.)
5. Connect a cable to the logger following [Connect the Cable and Sensor to the Logger](#).

### Change the Sensor on the MX802

To change the sensor on the end of the cable:

1. Insert a small screwdriver into the slot between the two straight coupler halves, and gently twist the screwdriver to separate the two halves and remove them.
2. Detach the sensor from the cable by pulling it straight out. (Do not twist.)
3. Connect a new sensor to the cable following [Connect the Cable and Sensor to the Logger](#).

## Verify Water Level Accuracy

You can check the accuracy of the logger for water level measurements by deploying the logger's sensor end at two depths and comparing the difference in level readings in the data files. When verifying the accuracy this way, be sure to allow the sensor's temperature to stabilize at each depth.



For the MX802 logger, you can do a rough check of the absolute pressure accuracy by comparing pressure readings between the water level sensor and the logger's barometric pressure sensor. Pull the CTD sensor out of the water so that it is in the air the same as the barometric pressure sensor. Check the differential pressure with the app. The differential pressure should be zero or less than the sum of the error for the two sensors.

## Replacing the DO Sensor Cap

### Kit Contents

- Sensor cap
- O-rings (2)
- Instruction sheet
- Vacuum grease
- Wipes

### Replacing the Cap

The sensor cap has a 24-month typical life. Replacement caps are available from Onset.



**Important:** Do not allow moisture or humidity inside the cap. Keep the cap in its sealed package until you are ready to install it and then install it promptly. Keep the O-ring grooves dry and be sure the O-rings are not rolled or pinched inside the cap.

1. Unscrew the sensor cap from the sensor.
2. Remove the existing O-rings from the sensor.
3. Lubricate the new O-rings by rubbing a dab of O-ring lube with your fingers to achieve a thin coating on all surfaces of the O-rings.
4. Slide the new O-rings into the O-ring grooves on the sensor.
5. Check the sensor window to make sure you did not get any O-ring grease on the window. If you did, clean the window with the wipe supplied with the replacement cap.
6. Remove the new cap from its sealed package.
7. Align the lines on the cap with the contacts on the sensor and press it firmly, without twisting, until it seals over the probe body. Make sure that the O-rings are not pinched or rolled between the cap and sensor.
8. Replace the sensor cap.
9. Calibrate the sensor according to [DO Sensor Calibration](#), if necessary.

## Use a Conductivity Sensor Anti-Fouling Guard

You can use an anti-fouling guard to protect your conductivity sensor. Contact your Onset sales representative to obtain a guard.



To install the copper guard:

1. Slide one of the O-rings so that it is above the conductivity sensor.
2. Then slide the copper guard over the sensor.
3. Position the guard so the holes are over the conductivity sensor.
4. Finally, slide the other O-ring on to hold the guard in place.

To remove the copper guard to facilitate cleaning, remove the outer O-ring and slide the anti-fouling guard off. When removing the anti-fouling guard, be careful to not exert excessive twisting force on the conductivity sensor.

## Use a DO Sensor Anti-Fouling Guard

You can use an anti-fouling guard to protect your DO sensor. You may want to use this to protect the DO sensor foil even if you do not need it for anti-fouling. Contact your Onset sales representative to obtain a guard.

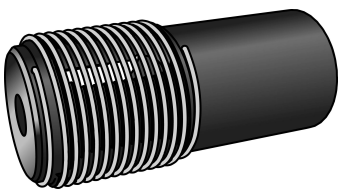

To install the copper guard:

1. Unscrew the guard that comes with the DO sensor.
2. Then slide the copper guard over the sensor.
3. Screw on the anti-fouling guard.

## Logger Events

The logger records the following events to track logger operation and status. You can view events in exported files or plot events in the app. To plot events:

1. Tap Data and select a file to open.
2. Tap the three-dots button (if applicable) and then tap the Graphs button. Select Events to see the recorded events on the plot and tap OK.

Internal Event Name	Definition
Host Connect	The logger was connected to the mobile device.
Started	The logger started logging.
Stopped	The logger stopped logging.
Alarm Tripped/Cleared	An alarm event has occurred because the reading was outside the alarm limits or back within range. Note: Although the reading may have returned to a normal range during logging, an alarm cleared event will not be logged if the logger was set up to maintain alarms until reconfigured.
New Interval	The logger has switched to a new multi-rate or burst logging interval.
Water Detect	The logger has entered the water or left the water. Note that handling the logger can also result in Water Detect Events.
Low Power	The battery level dropped below its normal operating voltage.
Safe Shutdown	The battery level dropped below a safe operating voltage and the logger performed a safe shutdown with all data stored in memory.
Cap Expiration	The cap on the DO sensor has expired. It has a life of 2 years. The logger continues to operate with the expired cap and it logs cap-expired events approximately every hour until the cap is replaced with a new cap. The cap-expired events include the sensor serial number.
Burst Alarm	The logger started logging in burst mode because the reading was outside the burst limits or reverted to the normal logging rate because the reading was back within range.

## Pressure Sensor Drift

All pressure sensors drift over time. The drift for the pressure sensors is less than 0.5% FS (worst case) per year. In most applications, drift is not a significant source of error because the offset created by any drift is zeroed out when you enter the reference water level in the app at the beginning of each deployment. In effect, you are re-zeroing the sensor each time you apply a reference reading to the data file.

Pressure sensor drift matters more when absolute pressure values are needed, or if there are no recent reference level or depth measurements available. For example, if the logger is deployed for one year and no new reference level readings are taken during the deployment, it is possible that the sensor could have drifted as much as 0.5% FS by the end of the deployment.

Compare the reference water level reading you took at the end of the deployment with the logged value that is closest to that in time. If the two readings are close, there is not much drift. If there are differences between these two figures, you must investigate further. The logger may have experienced sensor drift, a shift in the logger position during its deployment, or a difference in how you took the readings.

## Conductivity Sensor Calibration



**Note:** Calibrate the conductivity sensor before the logger starts logging. If the logger is already logging, stop it to recalibrate it and then restart it.

To perform the conductivity calibration you need the temperature coefficient for the calibration solution you are using. If you are using a potassium chloride solution, 1.91%/C is a good coefficient to use. For the most precise temperature compensation, see [Calculating a More Accurate Temperature Coefficient](#).

### Preparation

Follow these steps for the most accurate calibration.

We recommend soaking the sensor for 24 hours before calibrating it.

- The sensor connectors are not waterproof when disconnected; attach the sensor to an MX800 logger or sensor cable before putting it in the water, to avoid the chance of any water in the connection.
- If you are calibrating at 1,413  $\mu\text{S}/\text{cm}$  or less, use distilled or deionized (DI) water. For higher value calibration solutions, use tap water for the pre-soak.
- Rinse the sensor in tap water before putting it into the pre-soak water
- Pre-soak in the space that will be used for calibration so that the sensors will have reached temperature equilibrium before the calibration. This space should be between 15° and 30°C, and the closer to 25°C the better.
- We recommend calibrating the sensor without the anti-fouling guard on. However, if you want to calibrate with the anti-fouling guard on, ensure it is not trapping any air bubbles.

Choose your calibration solutions as follows:

- We recommend using Potassium Chloride (KCl) conductivity standards such as the ones sold by Onset (COND-CAL-x)
- We recommend using two calibration solutions that span your expected measurement range, one at the low end and one at the high end of the range.

- You can use up to 8 calibration points.
- You will need beakers for each calibration solution and rinse solutions of the same value.
- You will need beakers that allow the sensor to be submerged at least 2”.
- Place all calibration solutions, rinse solutions and loggers with sensors in the area where you will be doing the calibration. Do this in advance of the calibration so that they have time to reach the room temperature.

## Calibrating the Sensor

 **Note:** Start with the lowest conductivity and go up to higher conductivities.

When calibrating, for each calibration point:

1. Thoroughly rinse in deionized (DI) or distilled water. For calibration points higher than 1,413  $\mu\text{S}/\text{cm}$ , you can rinse it in tap water.
2. Submerge and rinse the sensor in a beaker with the pre-rinse calibration solution (that has the same value as reference solution). Submerge the sensor to at least 2” and tap the sensor and gently stir it to remove air bubbles.
3. Remove the sensor from the pre-rinse and gently shake off excess rinse solution.
4. Place the sensor in a second beaker with fresh reference calibration solution. Submerge the sensor to at least 2” and tap the sensor and gently stir it to remove air bubbles.
5. Enter the calibration screen in HOBOnnect (if you're not already there). To do so, move the magnet to the Wake icon on the logger. When you see the logger tile appear in HOBOnnect, click that tile. If HOBOnnect prompts you to calibrate the logger, click Yes. Otherwise, click Conductivity Calibration. The following window opens.

Conductivity Calibration
×

Calibration Point 1

Temperature <span style="font-size: 1.2em;">71.69</span> °F	Measured Conductivity <span style="font-size: 1.2em;">1531.43</span> $\mu\text{S}/\text{cm}$
Specific Conductance at 25°C <input style="width: 80px;" type="text" value="0"/> $\mu\text{S}/\text{cm}$ <span style="color: red; font-size: 0.8em;">Please enter reference conductivity</span>	Temperature Coefficient <input style="width: 80px;" type="text" value="1.91"/> %/°C

Start Calibration

6. Enter the Specific Conductance and the Temperature Coefficient of the reference calibration solution into the calibration screen. 1.91%/°C is the standard Temperature Coefficient for Potassium Chloride reference solutions. For even greater accuracy, calculate a temperature-specific temperature coefficient as described in [Calculating a More Accurate Temperature Coefficient](#).
7. Tap Start Calibration. Once the sensor has been in the calibration solution for at least two minutes, and the app indicates the reading is stable, tap Confirm.
8. To add another calibration point, repeat the above steps, staying in the HOBOnnect calibration loop.
9. Once you have entered the desired number of calibration points, save your calibration.
10. When done, rinse the sensor with tap and DI water (deionized water) to prevent salt from hardening on the electrodes.

**Notes:**

- If you become disconnected from your logger during the calibration process it is possible to resume the calibration. You must use the same device used for the initial calibration points.
- For the best accuracy, if you are going to use your logger again soon, store the sensor in tap water after calibration until it is deployed.
- For longer term storage, it is ok to store the sensor dry.
- You can do this calibration in the field, but it will not be as accurate.
- As an alternative to lab calibration solutions, you may use seawater from the site in combination with a calibrated conductivity meter that can provide the specific conductance values to enter in HOBOnnect. Remember, this may not be as accurate.

## Calculating a More Accurate Temperature Coefficient

If the temperature in the space where you are performing your calibration is within a couple of degrees of 25°C and you are using a potassium chloride reference solution, use the default temperature coefficient of 1.91%/°C.

For temperatures that are significantly higher or lower than 25°C, look for a table on the calibration solution bottle that shows the conductivity at a range of temperatures such as the one below.

The calibration solution label shows the electrical conductivity (EC) values at multiple temperatures. Find the EC at the temperature closest to the current temperature. To calculate the temperature coefficient, use the following formula:

$$\text{Temperature Coefficient} = ((\text{SC} - \text{ECt}) / \text{SC}) / (25 - \text{T})$$

Where this...	means this.
SC	Rated specific conductivity of the calibration solution at 25°C.
T	The closest temperature on the label to the current temperature.
ECt	Electrical conductivity at T

Example:

The current temperature is 20.3°C for the 80,000 µS/cm reference calibration solution with the label below.

$$\text{Temperature Coefficient} = ((80,000 - 72,900) / 80,000) / (25 - 20)$$

$$= 8.875\% / 5^\circ\text{C}$$

$$= 1.78\% / ^\circ\text{C}$$

The result is that the temperature coefficient is 1.78%/°C.

<b>ONSET®</b>		
<b>Part No.: COND-CAL-4</b>		
<b>Description: Potassium Chloride (KCl)</b>		
<b>Conductivity Standard</b>		
<b>Value: 80000 uS/cm +/- 1% @ 25C</b>		
<b>Quantity: 475mL</b>		
<b>STORE AT ROOM TEMPERATURE</b>		
<b>Lot No.: 123456</b>		
<b>Expires:01/2025</b>		
°C	°F	Conductivity(uS/cm)
5	41	53800
10	50	58900
15	59	65700
16	60.8	67200
17	62.6	68700
18	64.4	70100
19	66.2	71500
20	68	72900
21	69.8	74300
22	71.6	75800
23	73.4	77200
24	75.2	78600
25	77	80000
26	78.8	81600
27	80.6	83100
28	82.4	84700
29	84.2	86200
30	86	87700
31	87.8	89400

## DO Sensor Calibration

For the best accuracy, we recommend calibrating the DO sensor when you install a new DO sensor cap or before a new deployment.

There are two calibration options:

- DO Percent Saturation Calibration, which is the most common method.
  - Can use the calibration boot supplied with the sensor or 100% DO saturated fresh water using a bubbler.
  - Requires barometric pressure: If you calibrate it with an MX802 logger, the calibration software uses the barometric pressure reading from that logger. If you calibrate it with an MX801 you will need a source for the current barometric pressure reading.
- DO Concentration Calibration
  - This method requires an accurate way to measure the salinity-adjusted DO concentration in mg/L, such as a meter or a Winkler titration.
  - This method works with either fresh or salt water reference solutions.
  - You will also need to enter the salinity of the water.

Both methods allow for either a 1-pt or 2-pt calibration, with the second point being a zero-point calibration. In most cases, a 1-pt calibration is enough to achieve the full accuracy. In most cases the sensor's factory zero point calibration meets the accuracy specification without requiring you to do a zero-point calibration. The zero-point calibration will only make a difference for waters with DO levels of 4 mg/L or less. Furthermore if you do a 0-point calibration in sodium sulfite solution, you must be very careful to not leave any residue of that on the sensor as that can affect the accuracy of your measurements.



**IMPORTANT:** Calibration affects data only in future deployments; any data already logged is based on previous calibration values.

### Step 1: DO Percent Saturation Calibration

To complete these steps, you need fresh water, the calibration boot and sponge supplied with the logger, and a source for current barometric pressure at your current location. If you are calibrating to 0% saturation, you also need an accurate 0% DO calibration solution such as sodium sulfite solution and a beaker that can hold 5 cm (2") of calibration solution.

The fresh water, logger, and sodium sulfite (if applicable) should be left out in the lab where the calibration is being done long enough so that they are at room temperature. If the logger was deployed previously, make sure the sensor is clean and dry (see [Maintain the Logger and Sensors](#) for more details).



1. Make sure the sensor is attached to a HOBO MX800 series logger and that a DO sensor cap is on the sensor, held in place with the guard that came with the DO sensor (not the anti-fouling guard).
2. Wet the small sponge with fresh water. Squeeze out any excess water.
3. Place the sponge in the end of the calibration boot, being sure to press it all the way to the end with the hole.
4. Insert the sensor in the calibration boot to the line marked “calibration boot”. This ensures there is enough space between the end of the sensor and the sponge (the logger should not be pressed up tightly against the sponge).
5. Connect to the logger using HOBObconnect. Stop the logger if it is currently logging.
6. Select DO Percent Saturation Calibration.
7. Use the countdown timer to know when the sensor has been in the boot long enough to reach temperature equilibrium. Once the sensor has been in the boot for 10 to 15 minutes, click Proceed to Calibration.
8. The screen shows the current temperature and DO that the sensor is reading. The DO reading shown is based on the most recent calibration. If the DO sensor is connected to an MX802 logger, the screen shows its current barometric pressure reading. If the sensor is connected to an MX801 logger, enter the current barometric pressure from a nearby meter or MX802 logger in the space.
9. Start the calibration. The software will take a series of readings and notify you when the readings are stable.
10. Once the readings are stable, tap confirm to accept the calibration point.



**Note:** If you decide you do not need to change the calibration, click “X” to cancel the calibration and revert back to the last saved calibration values.

11. This calibration summary screen shows the temperature, measured uncalibrated DO value, and the barometric pressure for this calibration point. (Note that the measured uncalibrated DO value may be different than the DO value shown on the previous screen, which was the value measured using the previous calibration.)
12. If you are doing just a 1-point calibration, tap Finish Calibration and the calibration will be saved to the sensor.

## Step 2: 0% Saturation Calibration (optional)

1. Pour enough sodium sulfite into the beaker so that the DO sensor is at least 2” submerged.
2. Place the sensor into the solution and gently tap the sensor while holding it at a slight angle to release any bubbles on the sensor face. Once there are no more bubbles you can allow the sensor to rest on the bottom of the beaker. Make sure the logger is supported so that it does not tip over the beaker.
3. Wait for approximately 15 minutes until the sensor reaches temperature equilibrium. If you want to exit the 0% calibration and keep only the first calibration point, tap Discard.

4. Once it has reached equilibrium tap Start Calibration.
5. Once the readings are stable, tap Confirm.
6. This screen shows the temperature, measured uncalibrated DO value, and the barometric pressure for this 0% calibration. (Note that the measured uncalibrated DO value may be different from the DO value shown on the previous screen, which was the value measured using the previous calibration.)
7. When you are satisfied with the results tap Finish Calibration.
8. The calibration values are stored as part of the data file.
9. Remove the sensor from the solution and thoroughly rinse it with fresh water to remove any excess sodium sulfite, and then soak it for an hour in fresh water, and rinse it again to be sure all residue is removed.

### **Step 1: DO Concentration Calibration**

This method requires an accurate way to measure the salinity-adjusted DO concentration in mg/L, such as a meter or a Winkler titration to measure the actual DO next to the DO sensor. You may also want to have a bucket to pull up a sample of water from the site. This method works with either fresh or salt water, however if you are using saltwater, you will need a meter that can read the salinity-adjusted DO. If you will be doing a zero-point calibration, you will also need an accurate 0% DO calibration solution such as sodium sulfite solution and a beaker that can hold 5 cm (2") of calibration solution.

As much as possible, the sensor should be at the same temperature as the water and sodium sulfite (if applicable). If the logger was deployed previously, make sure the sensor is clean and dry.

1. Make sure the sensor is attached to a HOBO MX800 series logger and that a DO sensor cap is on the sensor, held in place with the guard that came with the DO sensor or the antifouling guard.
2. If you are using a meter:
  - a. Put the sensor and the meter's sensor in the water next to each other and at the same depth.
  - b. Gently stir or tap the sensors to make sure there are no bubbles trapped on the sensor face.
  - c. Allow them both to reach temperature equilibrium. (Step 6)
3. If you are using a Winkler titration or other water sampling method:
  - a. Place the DO sensor in the water you are using as your calibration reference.
  - b. Gently stir or tap the sensors to make sure there are no bubbles trapped on the sensor face and allow it to reach temperature equilibrium.
  - c. Allow the sensor time to reach temperature equilibrium. (Step 6)
  - d. Take a sample of water from next to the sensor at the same depth as the DO sensor surface. Use a Winkler titration or other method to determine the DO concentration of the sample.
4. Connect to the logger using HOBObconnect. Stop the logger if it is currently logging.
5. Select DO Concentration Calibration.

6. Use the countdown timer to know when the sensor has been in the water long enough to reach temperature equilibrium. Once the sensor has been in the water for 10 to 15 minutes, click Proceed to Calibration.
7. The screen shows the current temperature and salinity-adjusted DO that the sensor is reading (based on the salinity measured by a CT or CTD sensor connected to the same logger or the salinity that you enter.) The DO reading shown is based on the most recent calibration.
8. Enter the salinity-adjusted DO from your meter or titration.
9. Start the calibration. The software will take a series of readings and notify you when the readings are stable.
10. Once the readings are stable, tap Confirm to accept the calibration point.



**Note:** If you decide you do not need to change the calibration, click “X” to cancel the calibration and revert back to the last saved calibration values.

11. This screen shows the reference reading and salinity and the measured temperature and uncalibrated salinity-adjusted DO value and the calculated slope for this calibration point. (Note that the measured uncalibrated DO value may be different from the DO value shown on the previous screen, which was the value measured using the previous calibration.)
12. If you are doing just a 1-point calibration, tap Finish Calibration and the calibration will be saved to the sensor.

## Step 2: 0% Saturation Calibration (optional)

1. Pour enough sodium sulfite into the beaker so that the DO sensor is at least 2” submerged.
2. Place the sensor into the solution and gently tap the sensor while holding it at a slight angle to release any bubbles on the sensor face. Once there are no more bubbles you can allow the sensor to rest on the bottom of the beaker.
3. Wait for approximately 15 minutes until the sensor reaches temperature equilibrium. If you want to exit the Zero-point calibration and only keep the first calibration point, tap Discard.
4. Once it has reached equilibrium, tap Start Calibration.
5. Once the readings are stable, tap Confirm.
6. This screen shows the reference reading as zero mg/L and the measured temperature and measured uncalibrated DO. (Note that the measured uncalibrated DO value may be different than the DO value shown on the previous screen which was the value measured using the previous calibration.)
7. When you are satisfied with the results, tap Finish Calibration. Otherwise, tap “X” to exit the calibration without saving the new calibration.
8. The calibration values are stored as part of the data file.
9. Remove the sensor from the sodium sulfite solution and thoroughly rinse it with fresh water to remove any excess sodium sulfite, and then soak it for an hour in fresh water, and rinse it again to be sure all residue is removed.

## Measurement Calculations

### Salinity

The MX800 loggers calculate salinity from the electrical conductivity and temperature measurements using the Practical Salinity Scale 1978 (PSS-78). Salinity is valid only for salinities in the range of 2 – 42 PSU and temperatures from -2C to 35C. For conditions outside these ranges, the loggers will record values, but those values should not be considered valid. For conditions outside the valid range, you should use calculation suitable for those conditions.

### Total Dissolved Solids (TDS)

The MX800 loggers calculate TDS from the Specific Conductance (Electrical conductivity at 25C):

- $TDS = k_e * \text{Specific Conductance}$ , where the Specific Conductance is in  $\mu\text{S}/\text{cm}$  and  $k_e$  is correlation factor between 0.3 and 1.0 and is based on the primary salts in the water.

# Specifications





## HOBO MX801/802 Specifications

Operating Range	-40° to 50°C (-40° to 122°F), cannot be frozen in ice
Radio Power	1 mW (0 dBm)
Transmission Range	Approximately 30.5 m (100 ft) line-of-sight
Wireless Data Standard	Bluetooth 5
Number of sensors that can be connected	2
Maximum cable length	120 m (400 ft.)
Logging Rate	5 seconds to 18 hours
Logging Modes	Fixed interval (normal or statistics), burst, or multiple intervals with up to 8 user-defined logging intervals and durations, with pause and repeat options
Start Modes	Immediate, next interval, button start (with magnetic fob) or date & time
Stop Modes	When memory is full, never stop (overwrite oldest data), date & time, or after a set logging period
Water Detect	Events are logged when the logger is submerged or removed from the water (MX801 only)
Time Accuracy	±1 minute per month at 0° to 50°C (32° to 122°F)
Battery	Four AA, 1.5 V lithium batteries, user replaceable
Battery Life	With W-CTD or W-CT sensors: 2 years, typical with 1-minute logging interval or slower. With W-DO sensor: 1-year, typical with 5-minute logging interval or slower. Faster logging or statistics sampling intervals, entering burst logging mode, excessive readouts, and remaining connected with the app will affect battery life.
Memory	730,000 measurements, divided between channels (4 Mbyte memory)
Data Download Time (with Bluetooth 5+ devices)	Full memory: Approximately 3.5 minutes 120,000 measurements: 1 minute May take longer the further the device is from the logger.
Weight	MX801: Logger only including batteries, 213g (7.51 oz) MX802: Logger only including batteries, 215g (7.58 oz) Tapered collar for MX801 and MX802: 11g (0.39 oz)

	2m Cable: 153g (5.40 oz) Straight collar: 4g (0.14 oz)
Dimensions	Logger diameter: 4.14 cm (1.62 inches) Length without sensor: 18.7 cm (7.38 inches) Length with W-CTD sensor: 36.5 cm (14.36 inches) Length with W-CT sensor: 35.2 cm (13.87 inches) Length with W-DO sensor: 42.1 cm (16.57 inches) Mounting loop: 1.27 x 2.26 cm (0.48 x 0.89 inches)
Wetted Materials	Logger: PVC housing with polyester film label, PET sensor connector end cap and mounting handle with EPDM and Buna-N O-rings, titanium screws; MX802 also has ePTFE vent Collar: HDPE, titanium screws <b>Note:</b> The logger should be mounted so that no metal parts of the logger or sensor are in contact with other metals.
Environmental Rating	MX801: IP68; waterproof to 100m (with sensor(s) attached) MX802: IP67, NEMA 6; Weatherproof (with cable or Termination Plug attached); this model is not waterproof

**Barometric Pressure: MX-802 Only**

Measurement & Calibrated Range	66 to 107 kPa (9.6 to 15.5 psia), -20° to 50°C (-4° to 122°F)
Pressure Accuracy*	Typical error: ±0.2 kPa (0.029 psi) Maximum error: ±0.5 kPa (0.073 psi)
Resolution	<0.01 kPa (0.0015 psi)
Pressure Response Time**	<1 second to 90% at a stable temperature
Contribution to Water Level Accuracy***	Typical error: ±0.075% FS, 0.3 cm (0.01 ft) water Maximum error: ±0.15% FS, 0.6 cm (0.02 ft) water

<b>Markings</b>	
	The CE Marking identifies this product as complying with all relevant directives in the European Union (EU).
	The UKCA marking identifies this product as complying with all relevant directives in the UK Declaration of Conformity.
	
	<p><b>KC Statement:</b> 해당 무선설비는 전파혼신 가능성이 있으므로 인명안전과 관련된 서비스는 할 수 없음</p> <p><b>Translation:</b> The service related to human safety is not allowed because this device may have the possibility of radio interference.</p>

\* **Pressure Accuracy:** Absolute pressure sensor accuracy includes all sensor drift, temperature, and hysteresis-induced errors.

\*\* **Changes in Temperature:** Allow 20 minutes in water to achieve full temperature compensation of the pressure sensor. There can be up to 0.5% FS of additional error due to rapid temperature changes.

\*\*\* **Water Level Accuracy:** With accurate reference water level measurement, known water density, and a stable temperature environment. System Water Level Accuracy equals the sum of the Barometric Water Level Accuracy plus the selected CTD sensor Water Level Accuracy.

## MX800 Series Logger

The following is a technical drawing of the logger with dimensions.

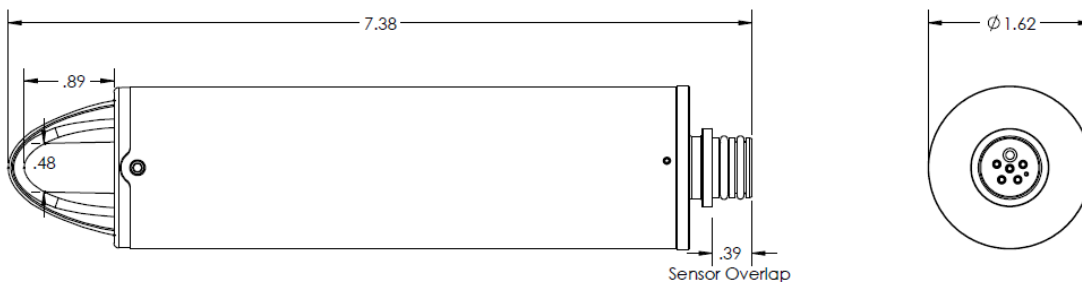

# CTD Sensor Specifications

## Conductivity Measurements

Measurement Range	Electrical conductivity and specific conductance: 0 to 100,000 $\mu\text{S}/\text{cm}$ Salinity using PSS-78: 2 to 42 PSU Total Dissolved Solids (TDS): 0 to 100,000 mg/L
Calibrated Range	Electrical conductivity: 50 to 80,000 $\mu\text{S}/\text{cm}$ 5° to 35°C (41° to 95°F)
Accuracy	Conductivity: +/-2% of reading or 15 $\mu\text{S}/\text{cm}$ , whichever is greater Salinity: +/-2% of reading or 0.1 PSU, whichever is greater (Error may be higher in air.)
Resolution	Conductivity: 0.1 $\mu\text{S}/\text{cm}$ from 0 to 1,000 $\mu\text{S}/\text{cm}$ 1 $\mu\text{S}/\text{cm}$ from 1,000 to 10,000 $\mu\text{S}/\text{cm}$ 10 $\mu\text{S}/\text{cm}$ from 10,000 to 100,000 $\mu\text{S}/\text{cm}$ Salinity: 0.01 PSU TDS: 0.1 mg/L
Response Time	1 second to 90% at a stable temperature

## Absolute Pressure and Water Level Measurements W-CTD-01

Range	0 to 207 kPa (0 to 30 psia); approximately 0 to 9 m (0 to 30 ft) of water depth at sea level, or 0 to 12 m (0 to 40 ft) of water at 3,000 m (10,000 ft) of altitude
Factory Calibrated Range	69 to 207 kPa (10 to 30 psia), 0° to 40°C (32° to 104°F)
Burst Pressure	310 kPa (45 psia) or 18 m (60 ft) depth
Water Level Accuracy*	Typical error: $\pm 0.05\%$ FS, 0.5 cm (0.015 ft) water Maximum error: $\pm 0.1\%$ FS, 1.0 cm (0.03 ft) water
Raw Pressure Accuracy**	$\pm 0.3\%$ FS, 0.62 kPa (0.09 psi) maximum error
Resolution	<0.02 kPa (0.003 psi), 0.21 cm (0.007 ft) water
Pressure Response Time***	<1 second to 90% at a stable temperature

## Absolute Pressure and Water Level Measurements W-CTD-02

Range	0 to 400 kPa (0 to 58 psia); approximately 0 to 30.6 m (0 to 100 ft) of water depth at sea level, or 0 to 33.6 m (0 to 111 ft) of water at 3,000 m (10,000 ft) of altitude
Factory Calibrated Range	69 to 400 kPa (10 to 58 psia), 0° to 40°C (32° to 104°F)



Burst Pressure	500 kPa (72.5 psia) or 40.8 m (134 ft) depth
Water Level Accuracy*	Typical error: $\pm 0.05\%$ FS, 1.5 cm (0.05 ft) water Maximum error: $\pm 0.1\%$ FS, 3.0 cm (0.1 ft) water
Raw Pressure Accuracy**	$\pm 0.3\%$ FS, 1.20 kPa (0.17 psi) maximum error
Resolution	<0.04 kPa (0.006 psi), 0.41 cm (0.013 ft) water
Pressure Response Time***	<1 second to 90% at a stable temperature

#### **Absolute Pressure and Water Level Measurements W-CTD-03**

Range	0 to 850 kPa (0 to 123.3 psia); approximately 0 to 76.5 m (0 to 251 ft) of water depth at sea level, or 0 to 79.5 m (0 to 262 ft) of water at 3,000 m (10,000 ft) of altitude
Factory Calibrated Range	69 to 850 kPa (10 to 123.3 psia), 0° to 40°C (32° to 104°F)
Burst Pressure	1,200 kPa (174 psia) or 112 m (368 ft) depth
Water Level Accuracy*	Typical error: $\pm 0.05\%$ FS, 3.8 cm (0.125 ft) water Maximum error: $\pm 0.1\%$ FS, 7.6 cm (0.25 ft) water
Raw Pressure Accuracy**	$\pm 0.3\%$ FS, 2.55 kPa (0.37 psi) maximum error
Resolution	<0.085 kPa (0.012 psi), 0.87 cm (0.028 ft) water
Pressure Response Time***	<1 second to 90% at a stable temperature

### Absolute Pressure and Water Level Measurements W-CTD-04



Range	0 to 145 kPa (0 to 21 psia); approximately 0 to 4 m (0 to 13 ft) of water depth at sea level, or 0 to 7 m (0 to 23 ft) of water at 3,000 m (10,000 ft) of altitude
Factory Calibrated Range	69 to 145 kPa (10 to 21 psia), 0° to 40°C (32° to 104°F)
Burst Pressure	310 kPa (45 psia) or 18 m (60 ft) depth
Water Level Accuracy*	Typical error: ±0.075% FS, 0.3 cm (0.01 ft) water Maximum error: ±0.15% FS, 0.6 cm (0.02 ft) water
Raw Pressure Accuracy**	±0.3% FS, 0.43 kPa (0.063 psi) maximum error
Resolution	<0.014 kPa (0.002 psi), 0.14 cm (0.005 ft) water
Pressure Response Time***	<1 second to 90% at a stable temperature

### Temperature Measurements (All Models)

Range	-20° to 50°C (-40° to 122°F), non-freezing water
Accuracy	±0.15°C (±0.27°F) from 0° to 50°C (32° to 122°F)
Resolution	0.01°C at 25°C (0.018°F at 77°F)
Response Time	3 minutes to 90% of the change in water (typical)
Drift	<0.1°C (0.18°F) per year

### Sensor

Dimensions	2.5 cm (1 inch) diameter, 18.7 cm (7.37 inches) length
Weight	177g (6.24 oz)
Wetted Materials	Passivated 316 Stainless steel housing rated for use in saltwater, Viton and Buna-N O-rings, PET sensor connector Depth sensor: ceramic Conductivity sensor: PET, platinum plating on electrodes Note: Sensor should be mounted so that it is not in contact with other metals
Environmental Rating	IP68; Waterproof to pressure sensor burst pressure rating

Markings	
	The CE Marking identifies this product as complying with all relevant directives in the European Union (EU).
	The UKCA marking identifies this product as complying with all relevant directives in the UK Declaration of Conformity.

\* Water Level Accuracy: With accurate reference water level measurement, known water density, and a stable temperature environment. System Water Level Accuracy equals the sum of the Barometric Water Level Accuracy plus the selected CTD sensor Water Level Accuracy.

\*\* Raw Pressure Accuracy: Absolute pressure sensor accuracy includes all sensor drift, temperature, and hysteresis-induced errors.

\*\*\* Changes in Temperature: Allow 20 minutes in water to achieve full temperature compensation of the pressure sensor. There can be up to 0.5% of additional error due to rapid temperature changes.

## CTD Sensor

The following is a technical drawing of the CTD sensor with dimensions.

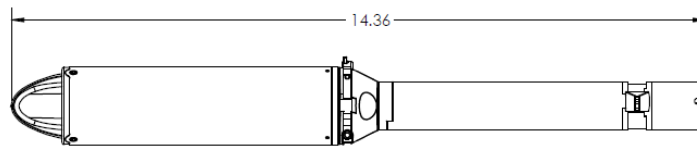
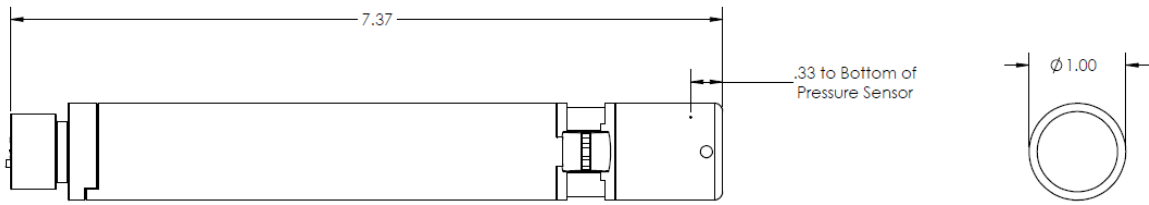

# CT Sensor Specifications

## Conductivity Measurements



Measurement Range	Electrical conductivity and specific conductance: 0 to 100,000 $\mu\text{S}/\text{cm}$ Salinity using PSS-78: 2 to 42 PSU Total Dissolved Solids (TDS): 0 to 100,000 mg/L
Calibration Range	Electrical conductivity: 50 to 80,000 $\mu\text{S}/\text{cm}$ 5° to 35°C (41° to 95°F)
Accuracy	Conductivity: +/-2% or 15 $\mu\text{S}/\text{cm}$ whichever is greater Salinity: +/-2% of reading or 0.1 PSU, whichever is greater (Error may be higher in air.)
Resolution	Conductivity: 0.1 $\mu\text{S}/\text{cm}$ from 0 to 1,000 $\mu\text{S}/\text{cm}$ 1 $\mu\text{S}/\text{cm}$ from 1,000 to 10,000 $\mu\text{S}/\text{cm}$ 10 $\mu\text{S}/\text{cm}$ from 10,000 to 100,000 $\mu\text{S}/\text{cm}$ Salinity: 0.01 PSU TDS: 0.1 mg/L
Response Time	1 second to 90% at a stable temperature

## Temperature Measurements

Range	-20° to 50°C (-40° to 122°F), non-freezing water
Accuracy	$\pm 0.15^\circ\text{C}$ ( $\pm 0.27^\circ\text{F}$ ) from 0° to 50°C (32° to 122°F)
Resolution	0.01°C at 25°C (0.018°F at 77°F)
Response Time	3 minutes to 90% in water (typical)
Drift	<0.1°C (0.18°F) per year

## Sensor

Dimensions	2.5 cm (1 inch) diameter, 17.4 cm (6.87 inches) length
Weight	144g (5.08 oz)
Wetted Materials	Passivated 316 Stainless steel housing rated for use in saltwater, Viton and Buna-N O-rings, PET sensor connector Conductivity sensor: PET, platinum plating on electrodes Note: Sensor should be mounted so that it is not in contact with other metals
Environmental Rating	IP68; Waterproof to 100m



Markings	
	The CE Marking identifies this product as complying with all relevant directives in the European Union (EU).
	The UKCA marking identifies this product as complying with all relevant directives in the UK Declaration of Conformity.

## CT Sensor

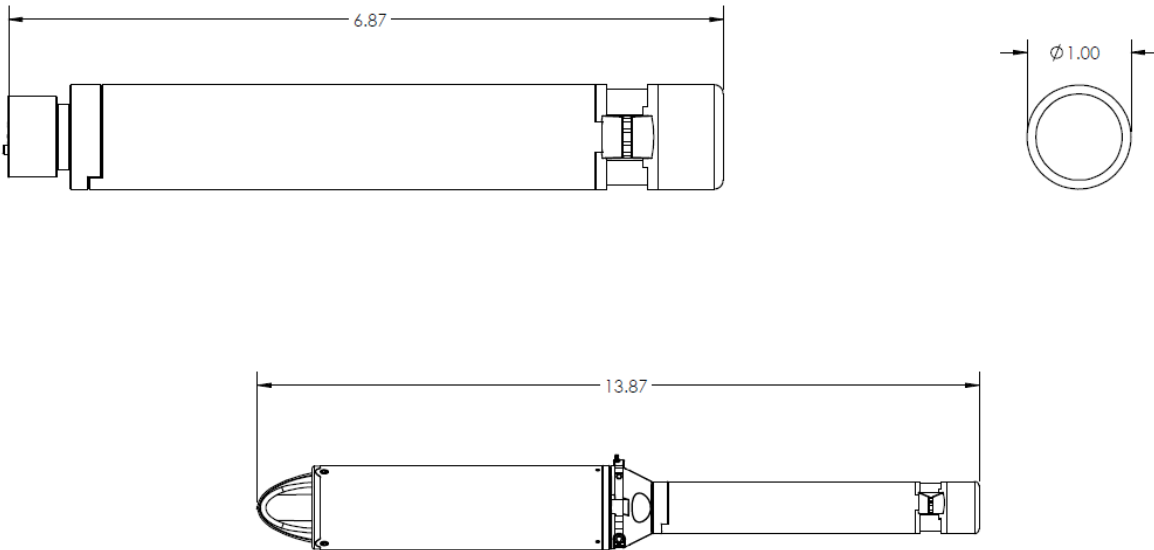
The following is a technical drawing of the CT sensor with dimensions.



# DO Sensor Specifications

<b>Dissolved Oxygen</b>	
Sensor Type	Optical (dynamic luminescence quenching)
Measurement Range	0 to 60 mg/L; 0-600% Saturation
Accuracy	Out-of-box: $\pm 0.2$ mg/L, typical over the range of 0 to 20 mg/L; $\pm 4\%$ , typical over the range of 20 to 60 mg/L With user calibration: $\pm 0.1$ mg/L over the range of 0 to 20 mg/L; $\pm 2\%$ over the range of 20 to 60 mg/L
Resolution	0.01 mg/L
Sensor Drift	Accuracy is maintained for 2 years; aside from the effects of fouling
Response Time	To 90% in less than 45 sec
DO Sensor Cap Life	2 years; after this the sensor will continue operate, but possibly with less accuracy
<b>Temperature</b>	
Temperature Measurement/ Operating Range	-5 to 50°C (23 to 104°F), non-freezing
Temperature Accuracy	0.15°C (0.27°F)
Temperature Resolution	0.01°C (0.04°F)
Response Time	To 90% in less than 15 minutes
Logging Rate	When using this sensor, the maximum logging rate is 1 min
Depth Rating	IP-68, waterproof to 100 m (328 ft) - must be attached to logger and have DO sensor cap installed
Wetted Materials	Black Delrin®, PVC, EPDM o-rings, rated for saltwater use
Dimensions	2.5 cm (1 inch) diameter, 24.28 cm (9.56 inches) length
Weight	Weight 144 g (5.08 oz)
<b>Markings</b>	
	The CE Marking identifies this product as complying with all relevant directives in the European Union (EU).
	The UKCA marking identifies this product as complying with all relevant directives in the UK Declaration of Conformity.

## DO Sensor

The following is a technical drawing of the DO sensor with dimensions.

